

Ultra SlimPak® Signal Conditioner Summary

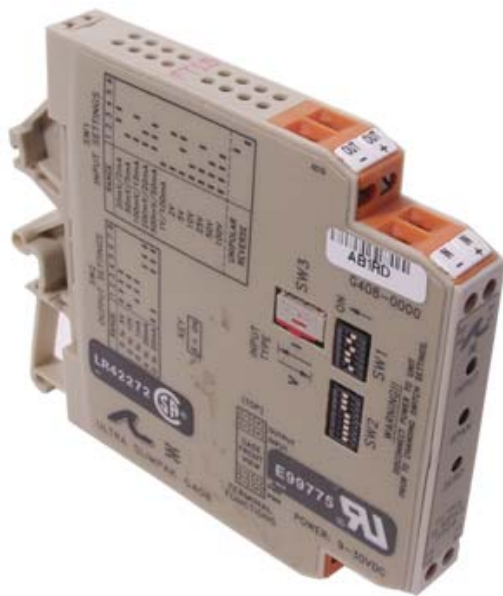

The Ultra SlimPak® family of analog signal conditioners are microprocessor based modules with DIP switch selectability of input and output ranges. Modules are either 12.7mm or 17.7mm wide and mount on both 32mm and 35mm DIN rails. There are 2 distinct series - the G1xx series with analog inputs and set-point relay outputs and the G4xx with analog inputs and outputs.

All are CSA and UL approved and are CE marked. All except one feature 3 port isolation. Power requirement is a wide range 9-30Vdc (except G448: 18-30Vdc).

For complete specifications please contact Weidmüller and request a copy of the appropriate data sheet (available in electronic format only) or download it from our website under Applications.

United States

Weidmüller Inc.
821 Southlake Blvd.
Richmond, Virginia 23236
Telephone: (800) 849-9343
Facsimile: (804) 379-2593
Email: info@weidmuller.com
Website: www.weidmuller.com





Canada

Weidmüller Ltd.
10 Spy Court
Markham, Ontario L3R 5H6
Telephone: (800) 268-4080
Facsimile: (905) 475-2798
Email: info1@weidmuller.ca
Website: www.weidmuller.ca

Mexico

Weidmüller, S.A. de C.V.
5 Sur No. 4311
Col. Huexotitla
72534 Puebla, Pue. Mexico
Telephone: (22) 37 2549
Facsimile: (22) 43 1981
Email: weidmull@acnet.net





Ultra SlimPak® Signal Conditioner Summary

Ultra SlimPak Product Matrix							
Input Type	Input Range	Output Range	Auxiliary Supply	Input to Output Isolation	Catalog Number	Output Configuration	Other Features
 DC Current	±1mA to ±100mA selectable	relay set point x 2	9-30Vdc	1800V	G108	Dual SPDT dry contact	EG12 housing
	±1mA to ±100mA selectable	0-5Vdc, 0-10Vdc, 0-1mA, 0-20mA or 4-20mA selectable	9-30Vdc	1800V	G408	4 wire	EG8 housing
	±1mA to ±100mA selectable	±5Vdc or ±10Vdc selectable	9-30Vdc	1800V	G408-1000	4 wire	EG8 housing
 DC Voltage	±10mVdc to ±200Vdc selectable	relay set point x 2	9-30Vdc	1800V	G108	Dual SPDT dry contact	EG12 housing
	±10mVdc to ±100Vdc selectable	0-5Vdc, 0-10Vdc, 0-1mA, 0-20mA or 4-20mA selectable	9-30Vdc	1800V	G408	4 wire	EG8 housing
	±10mVdc to ±100Vdc selectable	±5Vdc or ±10Vdc selectable	9-30Vdc	1800V	G408-1000	4 wire	EG8 housing
 RTD	Pt100, Pt500, Pt1000, Cu10, Cu100, Ni120 or NiFe604 selectable	relay set point x 2	9-30Vdc	1800V	G118	Dual SPDT dry contact	EG12 housing
	Pt100, Pt500, Pt1000, Cu10, Cu25 or Cu100 selectable	0-5Vdc, 0-10Vdc, 0-1mA, 0-20mA or 4-20mA selectable	9-30Vdc	1800V	G418	4 wire	EG12 housing
 Thermocouple	Type J, -210 to 760°C, Type K, -270 to 372°C, Type E, -270 to 1000°C, Type T, -270 to 390°C, Type R, 0 to 1760°C, Type S, 0 to 1750°C or Type B, 0 to 1820°C selectable	relay set point x 2	9-30Vdc	1800V	G128	Dual SPDT dry contact	EG12 housing
	Type J, -200 to 750°C, Type K, -200 to 1370°C, Type E, -150 to 1000°C, Type T, -150 to 400°C, Type R, 50 to 1760°C, Type S, 50 to 1760°C or Type B, 500 to 1820°C selectable	0-5Vdc, 0-10Vdc, 0-1mA, or 20mA or 4-20mA selectable	9-30Vdc	1800V	G428	4 wire	EG12 housing
 Potentiometer	0-100Ω to 0-100kΩ selectable	0-5Vdc, 0-10Vdc, 0-1mA, 0-20mA or 4-20mA selectable	9-30Vdc	1800V	G438	4 wire	EG8 housing



Ultra SlimPak® Signal Conditioner Summary

Ultra SlimPak Product Matrix

Input Type	Input Range	Output Range	Auxiliary Supply	Input to Output Isolation	Catalog Number	Output Configuration	Other Features
Bridge/Strain Gauge 	±5mVdc to ±200mVdc selectable 1 to 10Vdc adjustable excitation	0-5Vdc, 0-10Vdc, 0-1mA, 0-20mA or 4-20mA selectable	18-30Vdc	1800V	G448	4 wire	EG12 housing
AC Current 	0-10mAac to 0-100mAac selectable	relay set point x 2	9-30Vdc	1800V	G168	Dual SPDT dry contact	EG12 housing
	0-10mAac to 0-100mAac selectable	0-5Vdc, 0-10Vdc, 0-1mA, 0-20mA or 4-20mA selectable	9-30Vdc	1800V	G468	4 wire	EG8 housing
AC Voltage 	0-100mVac to 0-200Vac selectable	relay set point x 2	9-30Vdc	1800V	G168	Dual SPDT dry contact	EG12 housing
	0-100mVac to 0-250Vac selectable	0-5Vdc, 0-10Vdc, 0-1mA, 0-20mA or 4-20mA selectable	9-30Vdc	1800V	G468	4 wire	EG8 housing
Frequency 	0-2Hz to 0-10kHz selectable	0-5Vdc, 0-10Vdc, 0-1mA, 0-20mA or 4-20mA selectable	9-30Vdc	1800V	G478	4 wire	EG8 housing, "Touch Sample Technology"

Ultra SlimPak® Signal Conditioner Summary

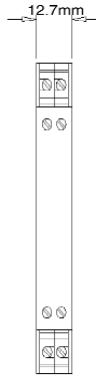
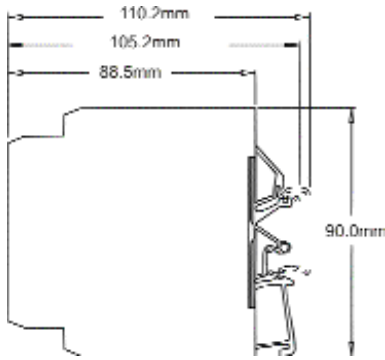

Number of screw clamps: 8

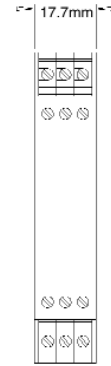

Number of screw clamps: 12

Housing dimensions

Width	12.7mm
Length	90.0mm
Height on TS35 x 7.5 rail	105.2mm
Height on TS32 x 15 rail	110.2mm
Height on TS35 x 15 rail	112.7mm

Cross connection

50 pole wire loop, 80mm, 16AWG

Marking

Preprinted for multipurposes (included with each Ultra SlimPak)
Blank, white 5mm

Width	12.7mm
Length	90.0mm
Height on TS35 x 7.5 rail	105.2mm
Height on TS32 x 15 rail	110.2mm
Height on TS35 x 15 rail	112.7mm

Type	Cat.No.
QD50 grey	023980

Type	Cat.No.
DEK 5/5 (preprinted)	990825
DEK 5/5	047336

Width	17.7mm
Length	90.0mm
Height on TS35 x 7.5 rail	105.2mm
Height on TS32 x 15 rail	110.2mm
Height on TS35 x 15 rail	112.7mm

Type	Cat.No.
QD50 grey	023980

Type	Cat.No.
DEK 5/5 (preprinted)	990825
DEK 5/5	047336

