



# Renewable energies: Components for photovoltaic systems

# Weidmüller components ...

Weidmüller is the leading provider of solutions for electrical connectivity, transmission, conditioning and processing of power, signals and data in industrial environments.

The company develops, produces and sells products in the field of electrical connectivity, functional electronics and communication electronics.

Weidmüller carries out its own research, development and production in Detmold, Germany, which underscores the company's commitment to innovation and the quality of its products.

With distribution and service companies in over 70 countries, we guarantee reliable product supply and first-class service, thus guaranteeing continued operations for your company.

Our engineers work daily towards tackling the challenges faced by customers around the world.



## Counters/supply

- Surge protection
- Terminals
- Labelling/markings

## Control/monitoring

- Surge protection
- Signal converters
- Displays
- Current and voltage monitoring

## Communication

- GPRS modem
- Switches
- Routers

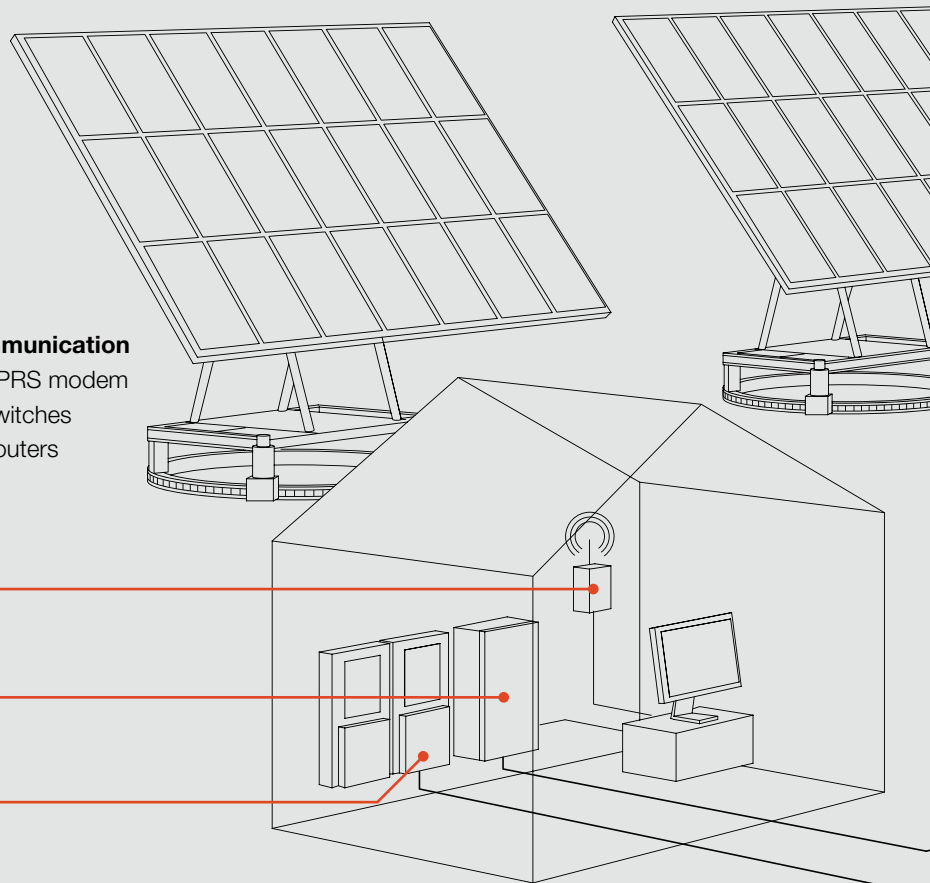

## ... for photovoltaic systems

For this reason, Weidmüller began working with solar energy technology early on and now produces a wide range of products for the safe and reliable operation of photovoltaic and solar thermal systems.

With a constant focus on maximum product availability for your system technology.

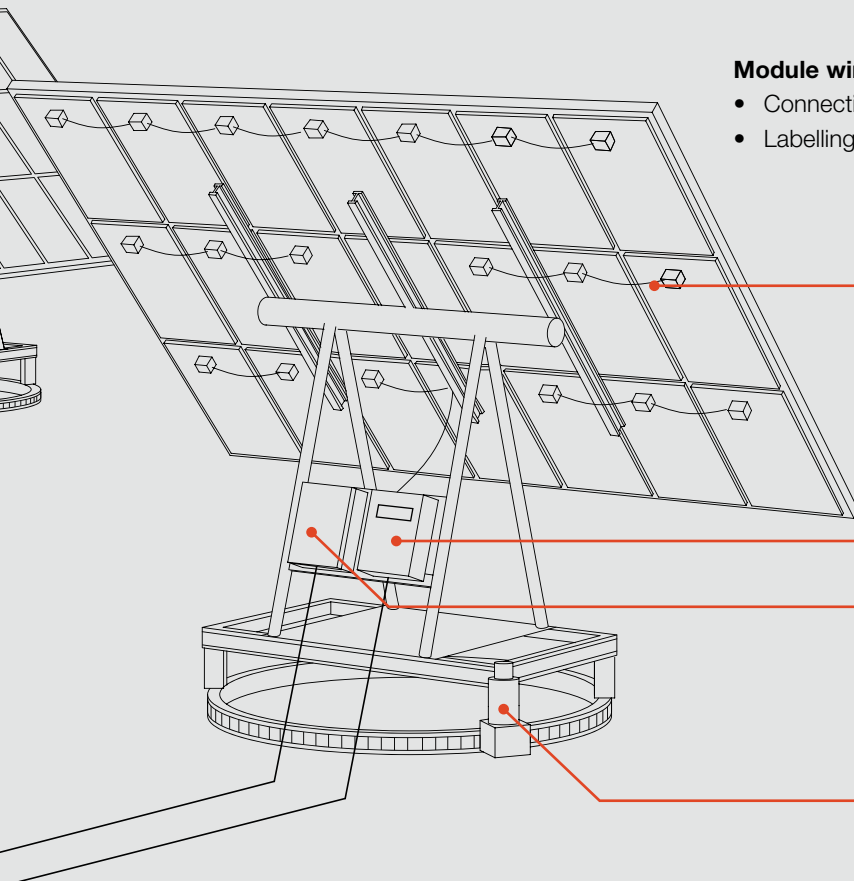

### Module wiring

- Connection technology
- Labelling / marking

### Controlling tracking systems

- Terminals
- Power supplies
- Signal conditioning
- Housing
- Surge protection

### Inverter

- PCB components
- Switches (communication)
- Housing
- Surge protection

### Drive

- Heavy-duty connector

# Lightning and surge protection



Damage caused by lightning strikes and power surges not only results in high repair costs, but also often contributes to machine and system downtime.

With our comprehensive range of surge protection modules, we offer you the right product for every application.

Our products provide you with the following advantages:

- Comprehensive range of consistent lightning protection zone concepts from classes I to III
- Surge protection for signals and data
- Pluggable, low-maintenance varistor charge eliminator
- Thermal and dynamic protection for the charge eliminator with network isolation in case of failure
- No decoupling between different lightning protection classes, so it is not necessary to take the lengths of the cable into consideration

Lightning poses a risk to photovoltaic systems that generate renewable energy because of their large surface areas and exposure to the elements. Damage can affect individual areas or cause the entire system to fail. To protect all devices, the energy supply lines need to be equipped with surge protection in accordance with IEC 60364-7-712.

To protect the operation of your system, Weidmüller provides all the products necessary for a comprehensive lightning and surge protection concept:

- Power line protection of (PU I 4 280V/12,5kA)
- Inverter protection
  - DC side (PU II 2+1 550V/40kA)
  - AC side (PU II 4 280V/40kA)
- Power supply unit protection (PU II 2 280V/40kA)
- Signal/control protection (MCZ OVP HF 5 V, MCZ OVP HF 12 V, MCZ OVP HF 24 V)

On request, we can provide pre-wired, individually configured products as a plug-and-play solution, integrated into one single housing.

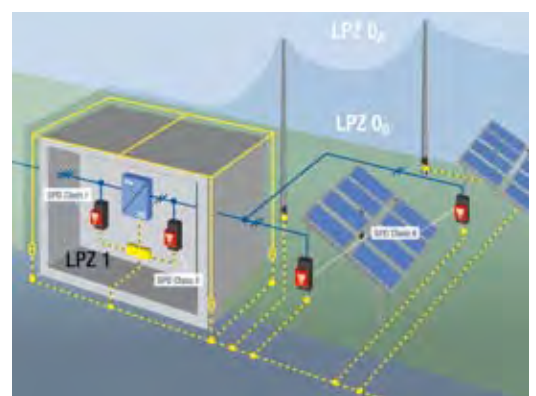



#### Lightning and surge protection, class II for AC/DC

- High energy absorption  $I_{max} = 40\text{ kA}$  per pole

##### **PU II 4 280V/40 kA – class II AC**

- 230/400 V charge eliminator, suitable for the TN CS energy network

##### **PU II 2+1 550V/40 kA – class II DC**

- 470/690V charge eliminator, suitable for photovoltaic voltages of up to 1,000 V



#### Lightning and surge protection class I for AC

##### **PU I 4 280V/12,5 kA – class I AC**

- High lightning leakage current of 12.5 kA per pole (10/350  $\mu\text{s}$ )
- Suitable for lightning protection levels III and IV
- No follow current
- Low protection level:  $U_p < 1.3\text{ kV}$
- Optical display, pluggable and rotates 180°



#### Surge protection as a plug-and-play solution

- Fully cabled housing
- Standard models for DC and AC/DC applications
- Multistringing box for 3 or more strings, with WTL 6/1 modular disconnect terminals
- Individual housing configurations on request, e.g. with surge protection, DC switches, fuses and DC connectors (e.g. MC-4)

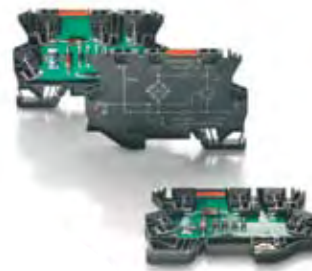

#### Surge protection charge eliminator for instrumentation and control (I&C)

##### **MCZ OVP HF**

- Narrow design of only 6 mm with tension clamp
- Surge protection for signals in 5V, 12V and 24V systems, such as Profibus, CAN, LON and DeviceNet
- Snap-on PE mounting rail contact
- Safe energy discharge of up to 10 kA

# Functional electronics



Our functional electronic products provide the ideal solution when it comes to recording, converting, connecting, switching, separating and amplifying analogue and digital process signals. Fuse components, surge protection elements, power supply and interface solutions complete the portfolio.

Among others, the following products are available for use in photovoltaic systems:

- Products for surge protection
- Analogue signal converters for measuring, monitoring and converting power
- Power supply units for supply components with DC voltage
- Electronic fuses to protect against surge
- Relays and optocouplers for switching between loads



## Current monitoring module

### 40/50/60 A AC/DC

- Indirect power measurement without having to isolate the cable
- Measuring AC and DC currents up to 60A
- Galvanic isolation of input and output
- Adjustable ranges via DIP switch
- Independent voltage of measuring circuit



## Isolating interface converter

### RS232/RS485/422

- Conversion from RS485/422 to RS232
- Galvanic isolation of both interfaces
- Narrow 22.5 mm housing
- Adjustable parameters via DIP switch
- Transmission rate up to 115.2 kbit/s



### Universal signal converter

---

#### ITXPlus

- Attachable power, voltage, resistance, thermal and RTD sensors
- 4 - 20mA output
- Monitoring and configuration via software
- Very narrow housing: 12.5 mm
- Galvanic isolation between input and output



### Energy supply

---

#### Ecoline

- Adjustable output voltage 24 - 28 V DC
- Monitoring via an LED status display
- External monitoring via signal contact
- Tool-less mounting on DIN rails
- 1 and 3-phase models

# Industrial Ethernet



Weidmüller has also developed reliable, consistent solutions in the field of Industrial Ethernet. From field-attachable connectors and industry-relevant cable connections to intelligent, active modules, we provide optimally coordinated components to help you implement your Industrial Ethernet networks.

All Weidmüller network components are designed down to the last detail with customer requirements in mind. They provide the necessary robustness for every application imaginable – be it as components for use in cabinets (IP20), for use in the field (IP67), for communication via copper or fibre-optic cables, or for wireless technology such as WLAN and Bluetooth.



## WaveLine Switch

---

Our IE-SWx-ETR-WAVE WaveLine switches are designed for use in the photovoltaic industry and will help your system to generate more power.

Every solar unit features a PLC controller so you can monitor the power generated and manage the intelligent tracking system, which ensures the ideal angle to receive sunlight. This controller is linked to the photovoltaic system's main control unit via the switch module.

With their expanded temperature range (-20 to 60°C), Weidmüller switches are designed to cope with extreme conditions and ensure fault-free data transmission.



## GPRS alarm modem

---

Weidmüller has incorporated the IE-GPRS-IO-QUAD alarm modem in its Ethernet range, so you have the option to access your system data online and on the go at any time. You can call up information around the clock no matter where you are.

Should your system exceed its predefined limits, an alarm signal is automatically sent to the person in charge by text message, fax or email.

You also have the option of accessing the system directly using an integrated RS 232 interface.

# STEADYTEC® connection technology

The purpose of the **STEADYTEC®** platform concept is to provide users with the convenience of always being able to find a connector to meet their requirements within a consistent system.

**STEADYTEC®** fulfils the most demanding requirements in terms of quality, system consistency, reliability, certification standards, flexibility, variety and modularity, and features four significant product advantages:

## Reliable

---

The materials used, the sealing technology, the contact reliability and the variety of housing all have to live up to the highest of standards to be incorporated into STEADYTEC®.

## Simple

---

Pre-fitted housing, marking rings and insulation displacement connections for the line connection ensure efficient and stress-free installation and maintenance work.

## Quick

---

**STEADYTEC®** connectors fulfil all requirements in terms of Cat. 6A and Class EA transmission rates. They are certified according to GHMT and 3P, and therefore guarantee reliable transmission for all Industrial Ethernet applications, from 10Mbit to 10Gbit.



## Solution-oriented

---

The comprehensive **STEADYTEC®** product range has the right solution for every requirement – be it standardised pin arrangements and locking mechanisms, fibre-optics and RJ45, plugs or sockets.

Particularly in applications that have to work in the most unfavourable environmental conditions, **STEADYTEC®** technology provides significant advantages. Thanks to its IP67 protection classification, excellent temperature stability and the UV-resistant protective housing, this range of connectors is ideal for use in your photovoltaic applications.



# Terminals



With increasing functionality, more compact models and highly complex energy and control technology components and systems, the requirements of electrical connection technology are on the rise. Product use, reliability and good customer service are all decisive factors in choosing the correct connection system.

Weidmüller can provide you with comprehensive solutions in all connection technologies – be it Push Ins, screw connections, tension clamps or insulation displacement connections.

The many technical details clearly demonstrate that our terminals adhere to the highest standards. We meticulously separate electrical and mechanical functions in our connection elements: hardened steel for the contact forces – copper with a tin coating for power transmission.

And WEMID, our own plastic, was developed for terminal housing and guarantees secure functionality in extreme temperatures, such as in a solar park.

Further outstanding features include:

- Space-saving design
- Vibration-resistant, low-maintenance connections
- Comprehensive, wide-ranging accessories
- Lots of space for labelling for easy classification
- Extensive national and international certifications

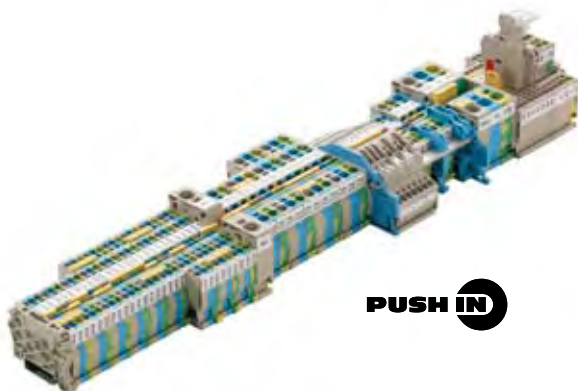

## P range / Push In connection technology

- Low wiring times
- Easy and safe to use
- Stripped, solid conductors or flexible conductors with wire end ferrules are simply plugged into the clamping point
- Vibration-resistant and gas-tight connections
- Wiring up to 16 mm<sup>2</sup> in just three sizes, reducing time in the planning phase as well as costs in purchasing, storage and mounting

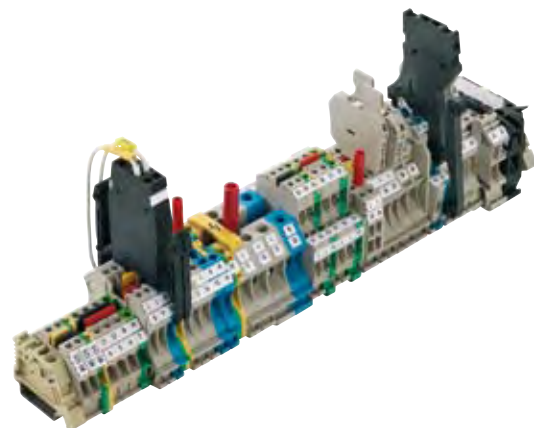

## W range / clamping yoke screw connection technology

- Conductor cross-sections from 0.05 to 300 mm<sup>2</sup>
- Ultra high contact forces
- Maintenance-free screw connection without having to retighten
- Screwable (WQV) or pluggable (ZQV) cross-sections for considerable time savings compared to all other screw terminals on the market
- Patented screw clamp construction principle – two conductors of the same cross-section can be connected to a single clamping point

# Tools



Weidmüller precision tools for cutting, stripping, crimping, screwing and testing are used all around the world. Our tools also guarantee consistent processing quality for your photovoltaic applications, day in, day out.

With its internal technical testing processes, Weidmüller guarantees the functionality, long life and quality of its tools. Even after many work cycles, we always guarantee consistent working results which fulfil national and international norms.



## Cutting tools

### KT 8 / KT 12

- For cutting copper and aluminium cables without damaging the lines
- Cutting formation for different cable sizes increases the quality of the cuts for smaller cross-sections
- Easy to use, can be tightened by hand, disengaging options in every cutting position



## VDE-insulated and uninsulated screwdriver

- Protective insulation according to IEC 900, DIN EN 60900 – up to 1,000V (AC) and 1,500V (DC)
- Easy to use in all handle sizes, optimum transmission of axial force for ultra high torque
- Range with all standard dimensions
- Torque screwdriver with click signal once the preset torque has been achieved



## Multifunctional stripping and cutting tools

### Multi-stripax®

- For flexible and solid conductors with special insulation and design
- Enables longer stripping lengths in several steps
- Various, interchangeable stripping units for excellent flexibility



## Measuring devices

### Digi Check 5.2

- Rate voltage range: 5–690 V AC/DC
- Illuminated LCD display, testing probe illumination
- Input resistance > 300 k $\Omega$ , resistance measurement (0 - 2 k $\Omega$ ), frequency measurement (0 - 2 kHz), capacity measurement (1 - 50  $\mu$ F)
- Polarity display, single-pole phase testing, direction of rotation testing, additional push-button for working resistance (2.5 k $\Omega$ ), hold function

## Customer-specific solutions ...



As a leading manufacturer of components for electrical connection technology, we focus on your specific requirements when developing tailor-made solutions.

After all, our philosophy focuses on the customer. Tell us what your requirements are and we will develop the perfect concept to boost your success – from consultation to product configuration and logistics.



Benefit from our comprehensive range of services:

- Production of pre-wired mounting rails and housing equipped with terminals and installation devices
- Housing with pre-fitted screw connections – available in standard and ATEX models
- Marking terminals, conductors and housing according to customer requirements
- Expertise in working with various housing materials such as aluminium, plastic, sheet steel and stainless steel
- Flexibility in the choice of product: we can also integrate your products, such as cables and switchgears
- Preassembled modules and construction kits such as heavy-duty connectors and PCB terminals with cable assembly
- Customer-specific modification of electronic components such as switched-mode power supply units, signal converters and interface units

Our certified production guarantees lasting high quality.



## ... for the technologies of tomorrow

Weidmüller provides housing configurations as plug-and-play solutions designed especially for use in the solar energy industry. Equipped and wired entirely in accordance with your specifications, all you have to do is connect them.

The technical features of these configurations are customised with the requirements of your photovoltaic applications in mind:

- Housing made of halogen-free, fibreglass-reinforced polyester
- IP65 protection classification
- AC housing with GSM modem and/or measurement electronics
- Models with surge protection modules
- For applications of up to 1,000V
- Certified according to IEC60439-1
- Additional equipment with main switches and fuses

In addition to the standard models, we can also develop and manufacture customised housing configurations for you.

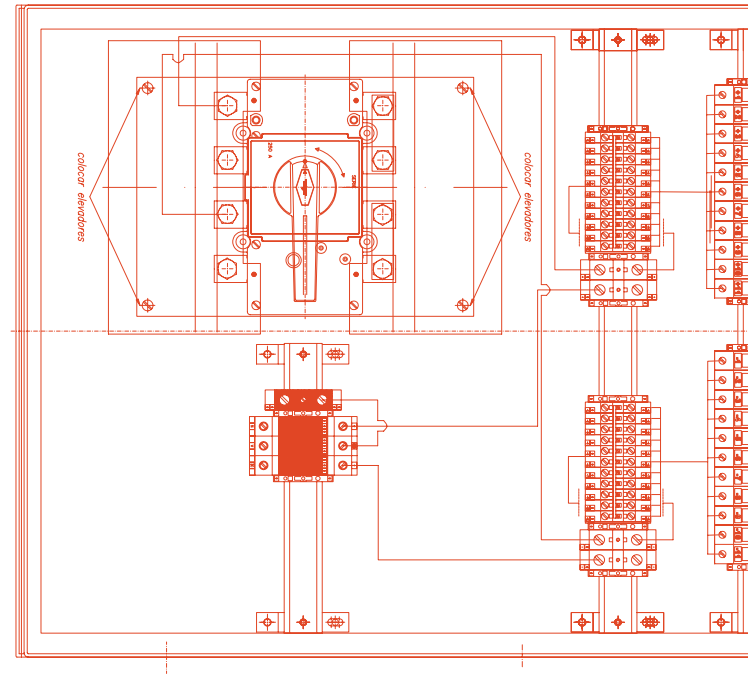

## OEM – individual product development

In modern automation technology, energy and control technology components and systems take on increasingly complex tasks. To design systems and devices as effectively as possible, we work with very clearly defined, individual guidelines. Inserted components are also evaluated according to these standards. And sometimes there are no adequate standard products on the market to meet your individual requirements.

If you have defined guidelines and functionalities such as these for your applications, Weidmüller's OEM department will develop an individual, innovative product for you.

Together we can come up with technical solutions in our innovation workshops for your photovoltaic applications. On request, we can assume complete responsibility for the project management, including a feasibility study, patent research and precise schedule planning. You benefit from our high quality standards and commitment to innovation as well as Weidmüller's expertise in all of its areas of operation – such as the use of components in extreme climatic conditions, UV-resistance and data transmission over long distances.

The result is a highly innovative, tailor-made solution that guarantees you a competitive edge in your photovoltaic applications.

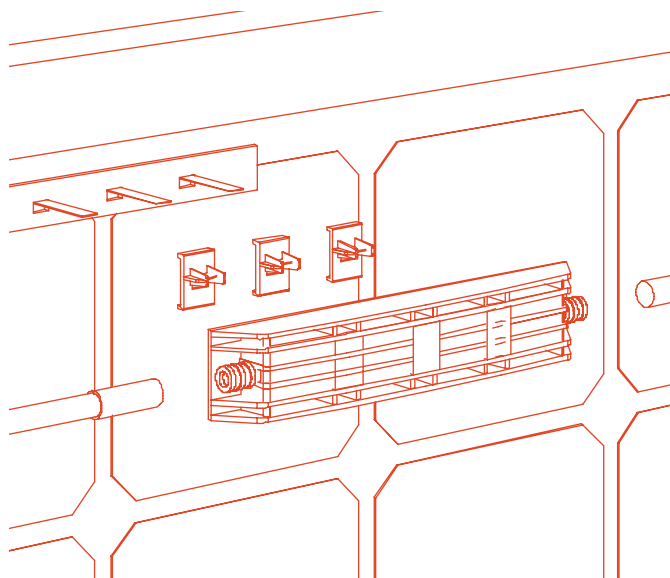



# www.weidmueller.com

Argentina	Indonesia	Saudi Arabia
Australia	Iran	Serbia
Austria	Ireland	Singapore
Azerbaijan	Israel	Slovakia
Bahrain	Italy	Slovenia
Belarus	Japan	South Africa
Belgium	Jordan	Spain
Bosnia and Herzegovina	Kazakhstan	Sweden
Brazil	Korea	Switzerland
Bulgaria	Kuwait	Taiwan
Canada	Latvia	Thailand
Chile	Lebanon	Tunisia
China	Lithuania	Turkey
Colombia	Luxembourg	Ukraine
Costa Rica	Macedonia	United Arab Emirates
Croatia	Malaysia	United States
Czech	Malta	Uruguay
Denmark	Mexico	Uzbekistan
Ecuador	Moldova	Venezuela
Egypt	Netherlands	Viet Nam
Estonia	New Zealand	
Finland	Norway	
France	Oman	
Germany	Pakistan	
Great Britain	Peru	
Greece	Philippines	
Hong Kong	Poland	
Hungary	Portugal	
Iceland	Qatar	
India	Romania	
	Russia	

**Weidmüller is the leading provider of solutions for electrical connectivity, transmission, conditioning and processing of power, signals and data in industrial environments. The company develops, produces and sells products in the field of electrical connectivity, functional electronics and communication electronics. Weidmüller's product and service portfolio is dedicated to add value to the products and thereby the business of our customers. The Weidmüller Group has a global focus with its own manufacturing plants, sales companies and representatives in over 70 countries.**

Order number:  
5664780000/09/2008/SMMD

