

PROPORT™ OFFERING
PROPORT™ OFFERING

PROPORT™ OFFERING

HEAVY DUTY CONNECTOR SYSTEM
FOR POWER AND DATA

PRODUCT INFORMATION

When good enough just isn't good enough

Weidmüller 

HEAVY DUTY CONNECTOR SYSTEM

ProPort™

FOR POWER AND DATA



ProPort™ products provide access to AC power and data signals from the outside of a control cabinet. Computers and programming devices can access a PLC within the cabinet without opening the cabinet door.

Products are available with D-sub, RJ or mini-DIN connectors. A single AC outlet is available with most connector types and a 5A circuit breaker is optional.

Most ProPort™ products are available with 2 or 3 variations for the connections on the inside of the cabinet - screw terminals, bulkhead connectors, or cables.



AC outlets and circuit breakers are connected via quick tab terminals.

Two unique additions to the ProPort™ offering allow access to 4-20mA loops through make-before-break connections. A meter can be inserted and removed from a loop without a momentary interruption.

The housings are from Weidmuller's standard HDC family. Features include hinged, gasketed covers with secure latching levers. Housings are made from die-cast zinc and are rated IP65 (equivalent to NEMA 4).



ProPort™ products are CSA approved.

ProPort™ Selection Matrix

Field Side				Reverse Side			Housing Size	Cat.#	Pg.
Conn. 1	Conn. 2	AC	C/B	Terminals	Bulk-head	Cable			
		•					3	7940000232	9
		•	•				6	7940000233	9
DB9-F				LM5.08			3	7940000256	3
DB9-F					DB9-M		3	7940000255	3
DB9-F						DB9-M	3	7940000254	3
DB9-F	DB9-F			LM5.08			8	7940000228	4
DB9-F	DB9-F				2xDB9-M		6	7940000227	4
DB9-F	DB9-F					2xDB9-M	6	7940000226	4
DB9-F		•		LM5.08			6	7940000219	3
DB9-F		•			DB9-M		6	7940000218	3
DB9-F		•				DB9-M	6	7940000217	3
DB9-F	DB9-F	•			2xDB9-M		6	7940000230	5
DB9-F	DB9-F	•				2xDB9-M	6	7940000229	5
DB9-M		•		LM5.08			6	7940000252	5
DB9-M		•			DB9-F		6	7940000251	5
DB9-M		•				DB9-F	6	7940000250	5
DB15-F		•			DB15-M		6	7940000221	6
DB15-F		•				DB15-M	6	7940000220	6
DB25-F		•			DB25-M		8	7940000224	6
DB25-F		•				DB25-M	8	7940000223	6
RJ12					RJ12		3	7940000243	8
RJ12	RJ12				2xRJ12		3	7940000240	8
RJ12		•			RJ12		6	7940000236	8
RJ45					RJ45		3	7940000241	8
RJ45					RJ45		3	7940000242	8
CAT5					CAT5				
RJ45		•			RJ45		6	7940000234	8
RJ45		•			RJ45		6	7940000235	8
CAT5					CAT5				
RJ45	RJ45				2xRJ45		3	7940000238	8
RJ45	RJ45				2xRJ45		3	7940000239	8
CAT5	CAT5				CAT5				
PS2	PS2					2xMini-DIN	3	7940000253	9
AB DH+						DB9-M	3	7940000244	7
AB DH+						Mini-DIN	3	7940000245	7
AB DH+				LM5.08			3	7940000246	7
AB DH+		•	•	LM5.08			8	7940000247	7
AB DH+		•	•			DB9-M	8	7940000248	7
AB DH+		•	•			Mini-DIN	8	7940000249	7
1/8" phono x 4 make-before-break				TOP 1.5			6	7926620004	10
1/8" phono x 8 make-before-break				TOP 1.5			10	7926620008	10

Housing dimensions located on page 11

**DB9-F Interface
Housing Size: 3**

FIELD VIEW

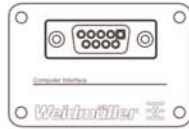

REVERSE VIEW

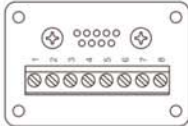

ELECTRICAL

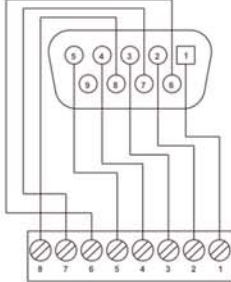

**Insert + Housing:
Catalog # 7940000256**

REVERSE VIEW

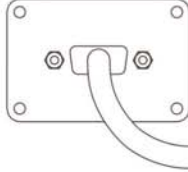

10 foot cable assembly

DB9 MALE

**Insert + Housing:
Catalog # 7940000254**

REVERSE VIEW

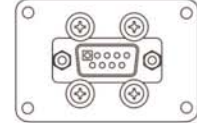

**Insert + Housing:
Catalog # 7940000255**

**DB9-F + AC Interface
Housing Size: 6**

FIELD VIEW

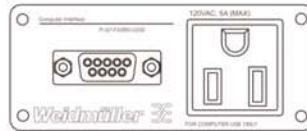

REVERSE VIEW

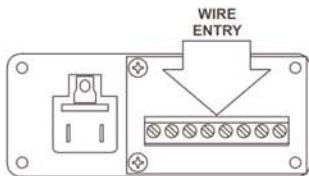

**WIRE
ENTRY**

ELECTRICAL

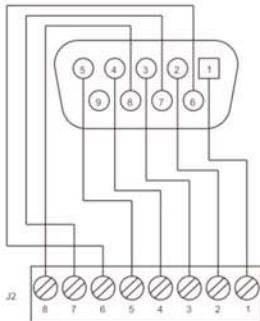

**Insert + Housing:
Catalog # 7940000219**

REVERSE VIEW

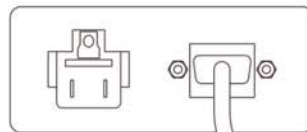

10 foot cable assembly

**Insert + Housing:
Catalog #: 7940000217**

REVERSE VIEW

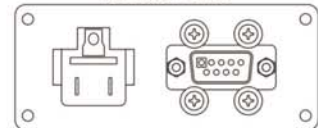

**Insert + Housing:
Catalog # 7940000218**

DB9M

DB9-F x 2
Housing Size: 6

FIELD VIEW

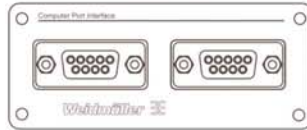

REVERSE VIEW

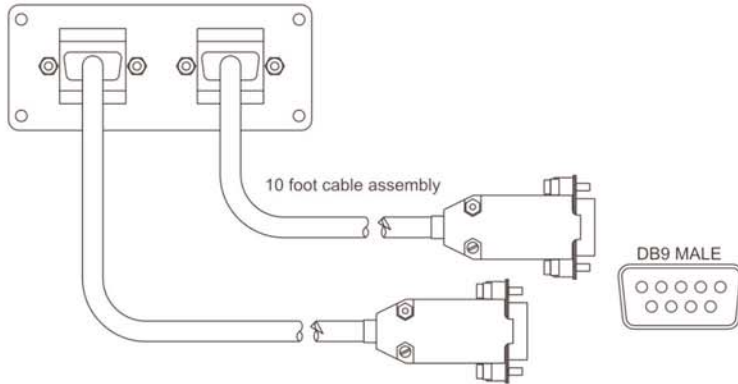

Insert + Housing:
Catalog # 7940000226

REVERSE VIEW

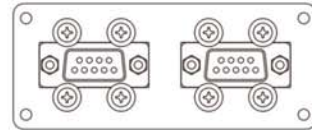

Insert + Housing:
Catalog # 7940000227

DB9-F x 2 to Terminals
Housing Size: 8

FIELD VIEW

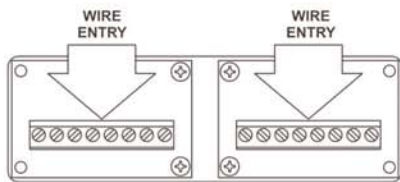
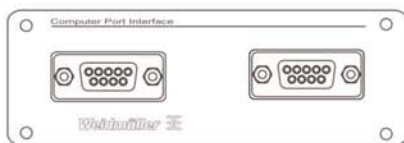

REVERSE VIEW

ELECTRICAL

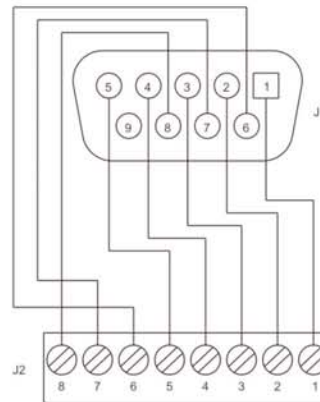

Insert + Housing:
Catalog # 7940000228

**DB9-F x 2 + AC Interface
Housing Size: 6**

FIELD VIEW

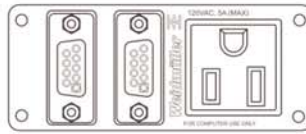

REVERSE VIEW

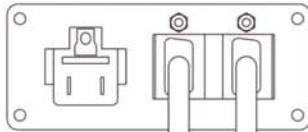

REVERSE VIEW

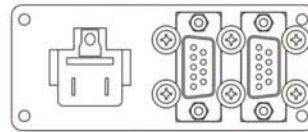

Catalog # : 7940000230

10 foot cable assemblies

**Insert + Housing:
Catalog # 7940000229**

DB9-M

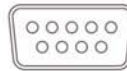

**DB9-M + AC Interface
Housing Size: 6**

FIELD VIEW

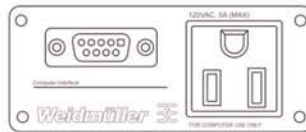

REVERSE VIEW

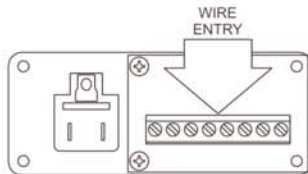

REVERSE VIEW

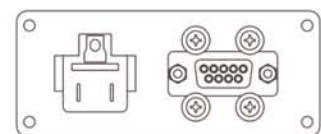

**Insert + Housing:
Catalog # 7940000251**

ELECTRICAL

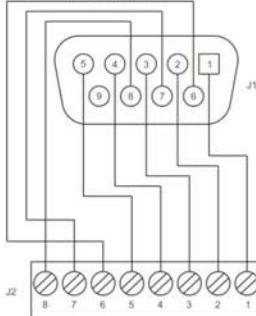

REVERSE VIEW

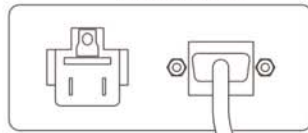

10 foot cable assembly

**Insert + Housing:
Catalog # 7940000250**

DB9F



**Insert + Housing:
Catalog # 7940000252**

**DB15-F + AC Interface
Housing Size: 6**

FIELD VIEW

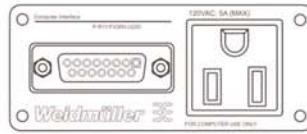

REVERSE VIEW

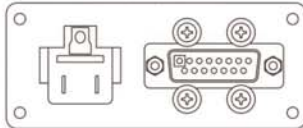

**Insert + Housing:
Catalog # 7940000221**

REVERSE VIEW

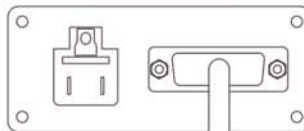

**Insert + Housing:
Catalog # 7940000220**

10 foot cable assembly

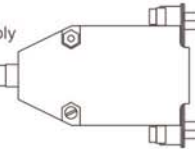

DB15 MALE



**DB25-F + AC Interface
Housing Size: 8**

FIELD VIEW

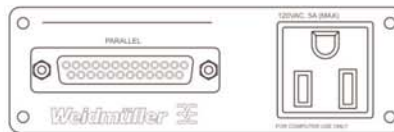

REVERSE VIEW



**Insert + Housing:
Catalog # 7940000223**

REVERSE VIEW

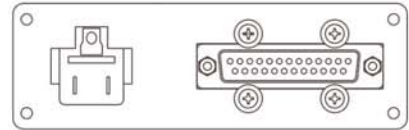

**Insert + Housing:
Catalog # 7940000224**

10 foot cable assembly

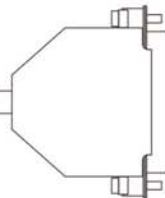

DB25 MALE



**AB DH+ Interface
Housing Size: 3**

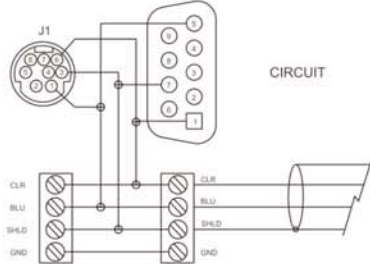
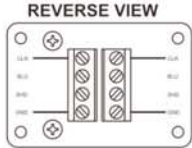

**Insert + Housing:
Catalog # 7940000246**

CABLE OPTIONS

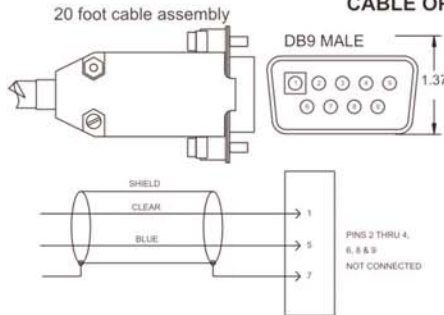

**Insert + housing:
Catalog # 7940000244**

20 foot cable assembly 8MDIN MALE

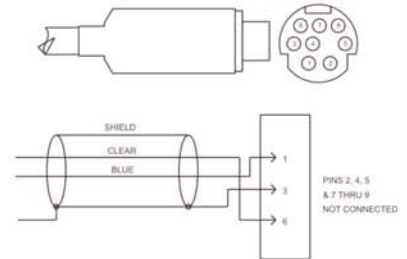

**Insert + housing:
Catalog # 7940000245**

**AB DH+ Interface
with AC Power + 5A Circuit Breaker
Housing Size: 8**

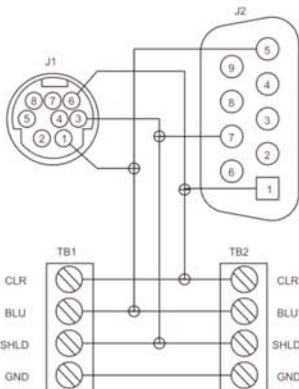
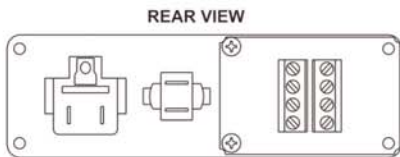
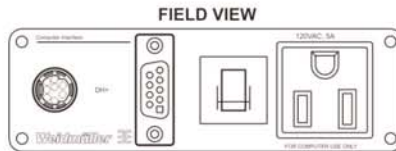

**Insert + Housing:
Catalog # 7940000247**

Cable Options

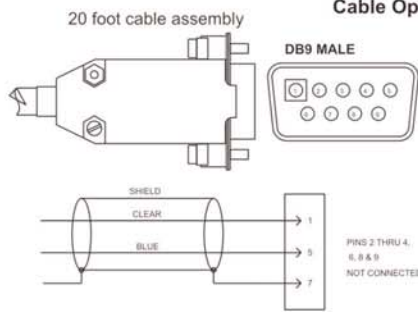

**Insert + Housing:
Catalog # 7940000248**

20 foot cable assembly 8MDIN MALE

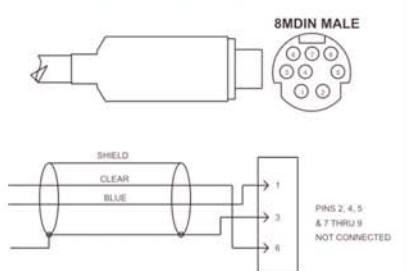

**Insert + Housing:
Catalog # 7940000249**

**RJ-45 x 2 Interface
Housing Size: 3**

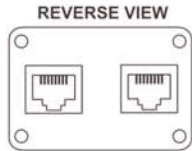
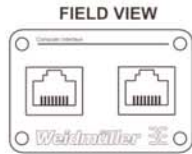

Insert + Housing:
Catalog # 7940000238

**RJ45 - CAT5 Interface
Ethernet
Housing Size: 3**

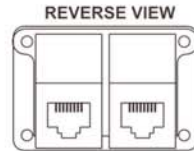
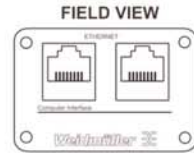

Insert + Housing:
Catalog # 7940000239

**RJ 12 6 pole x 2 Interface
Housing Size: 3**

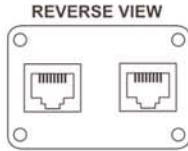
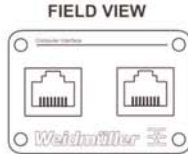

Insert + Housing:
Catalog # 79240000240

**RJ-45 Interface
Housing Size: 3**

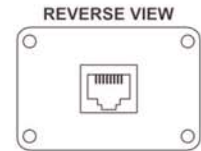
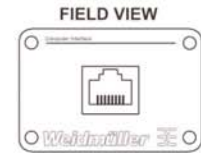

Insert + Housing:
Catalog # 7940000241

**RJ45 - CAT5 Interface
Housing Size: 3**

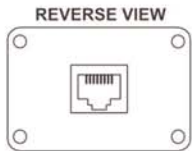
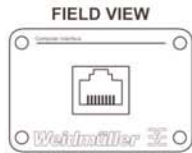

Insert + Housing:
Catalog # 7940000242

**RJ12 6 pole Interface
Housing Size: 3**

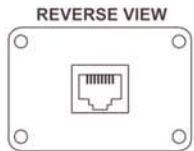
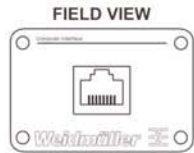

Insert + Housing:
Catalog # 7940000243

**RJ45 + AC Interface
Housing Size: 6**

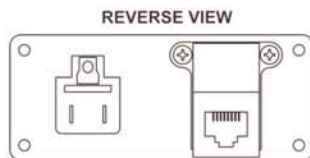
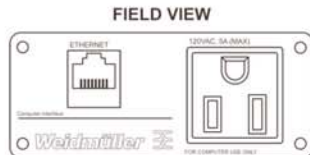

Insert + Housing:
Catalog #7940000234

**RJ45 (CAT5) + AC Interface
Ethernet
Housing Size: 6**

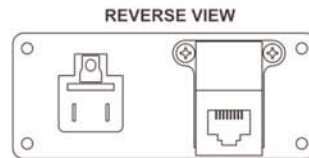
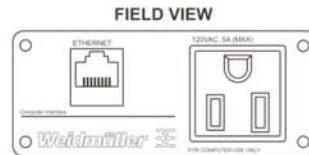

Insert + Housing:
Catalog # 7940000235

**RJ12 6 pole + AC Interface
Housing Size: 6**

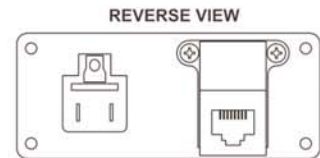
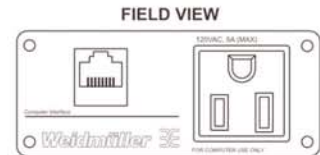

Insert + Housing:
Catalog # 7940000236

PS2 Keyboard & Mouse Ports
Housing Size: 3

FIELD VIEW

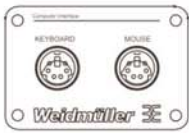

REVERSE VIEW

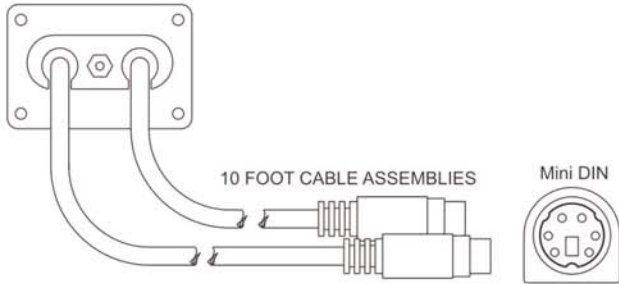

Insert + Housing:
Catalog # 7940000253

AC + 5A Circuit Breaker
Housing Size: 6

FIELD VIEW

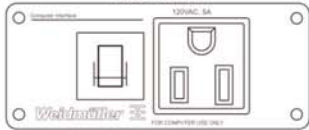

REVERSE VIEW

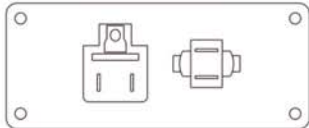

Insert + housing:
Catalog #: 7940000233

AC OUTLET
Housing Size: 3

FIELD VIEW

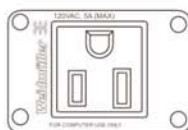

REVERSE VIEW

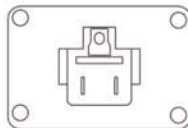

Insert + housing:
Catalog #: 7940000232



Proport™ for Current Loop Measurement

Specifications

Wire Size	22 - 14 AWG
Meter connection	1/8" phone jack (1 per channel) with make-before-break feature so loop is not interrupted
Protection rating	IP65

Catalog number

4 ch, size 6 housing	792662 0004
8 ch, size 10 housing	792662 0008
1 Meter test cable	991785 1000

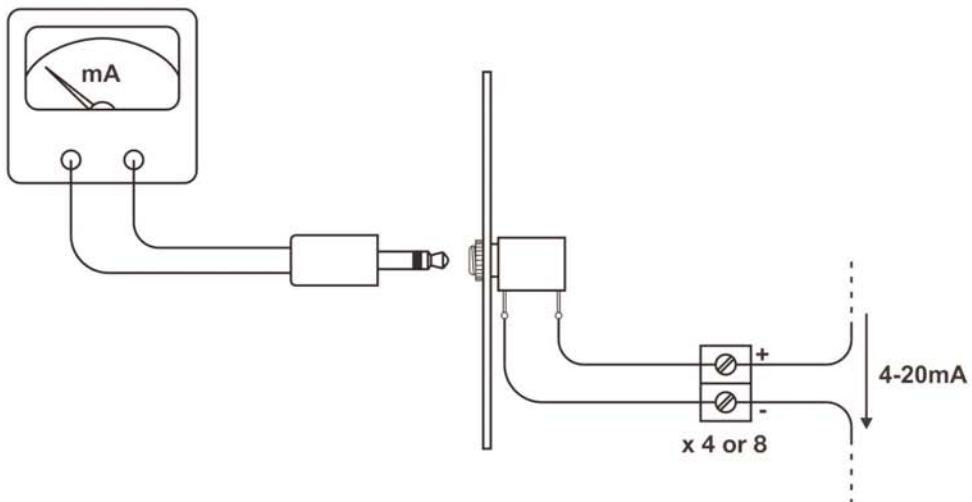

Housing Size: 3

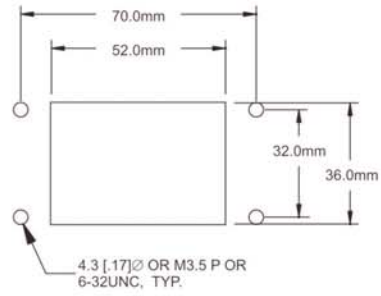
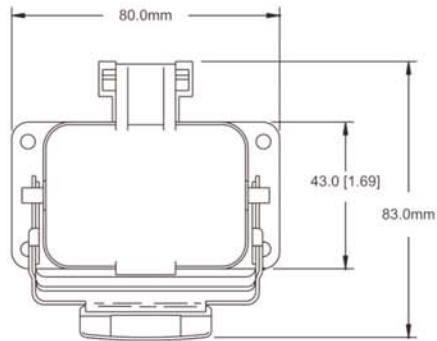

Housing Size: 6

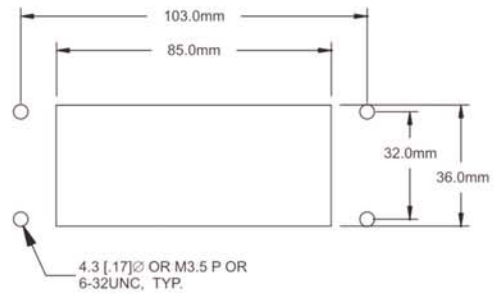
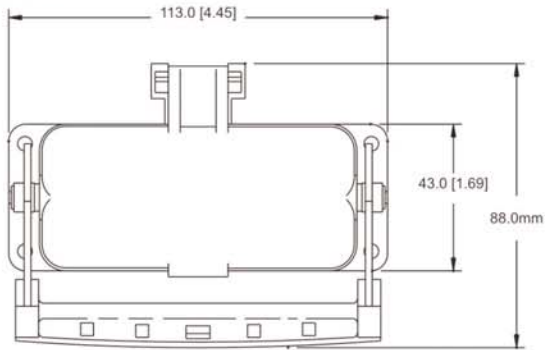

Housing Size: 8

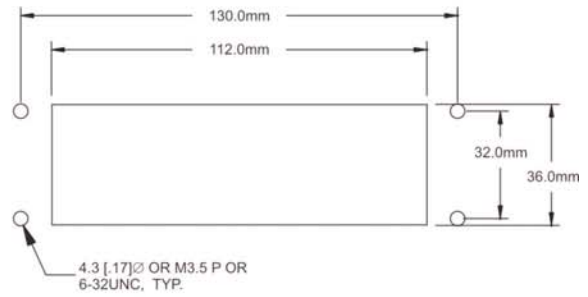
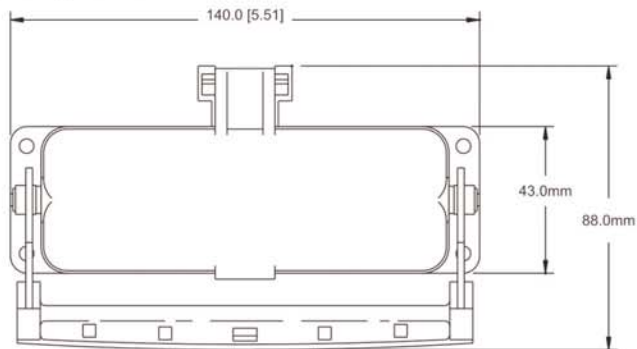

Housing Size: 10

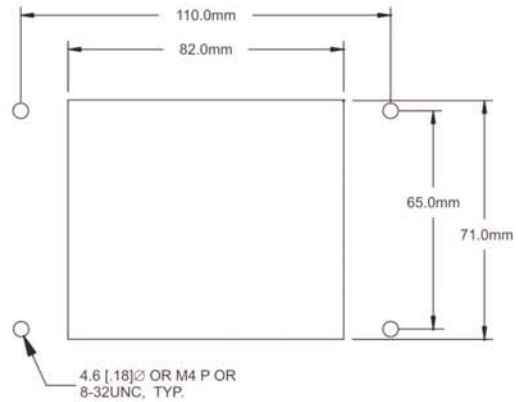
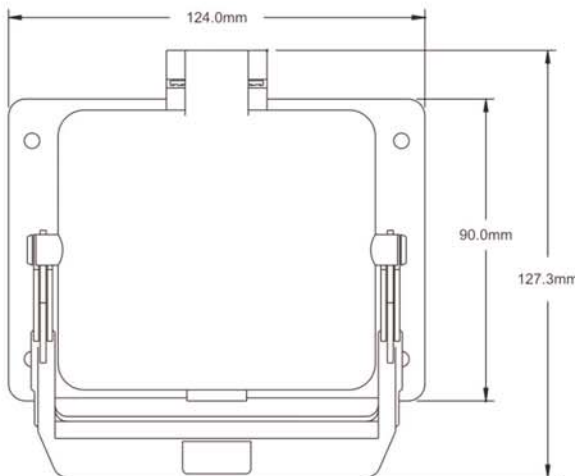

Argentina
Australia
Austria
Bahrain
Belarus
Belgium
Brazil
Bulgaria
Canada
Chile
China
Colombia
Croatia
Czech Republic
Denmark
Estonia
Finland
France
Germany
Great Britain
Greece
Hong Kong
Hungary
India
Indonesia
Iran
Ireland
Israel
Italy
Japan
Korea
Luxembourg
Malaysia
Mexico

Morocco
Netherlands
New Zealand
Norway
Pakistan
Peru
Philippines
Poland
Portugal
Romania
Russia
Saudi-Arabia
Singapore
Slovakia
Slovenia
South Africa
Spain
Sweden
Switzerland
Taiwan
Thailand
Turkey
UAE
Ukraine
USA
Vietnam
Yugoslavia



www.weidmuller.ca www.weidmuller.ca

www.weidmuller.ca

Weidmüller is the leading manufacturer of components for electrical connection technology.

We develop, produce and sell a wide spectrum of products from terminal blocks through connectors to relay sockets and I/O sockets for every type of application.

Order number:

Printed in Canada. 99990264/07/2005 rev